

PRODUCT SPECIFICATION

cosmo ELECTRONICS CORPORATION	Reed Relay : D2A240000	NO. 50R01015 SHEET 1 OF 3	REV. 5

1. OUTSIDE DIMENSION : UNIT (mm)

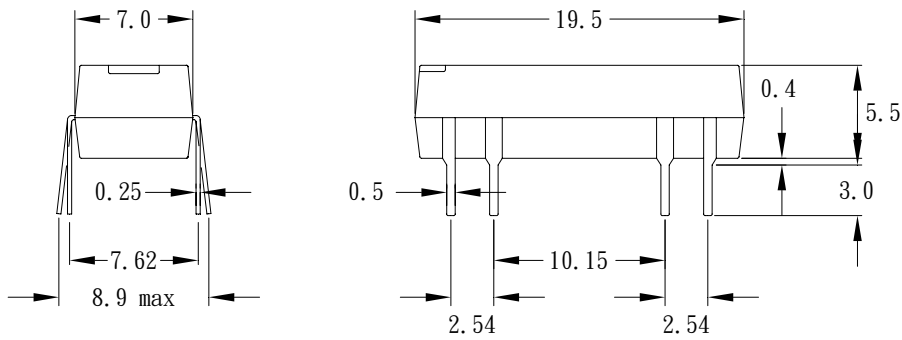

TOLERANCE : (1) 0. XX +/-0.1mm (2) X. XX +/-0.5mm (3) XX. XX +/-1.0mm

2. SCHEMATIC : TOP VIEW

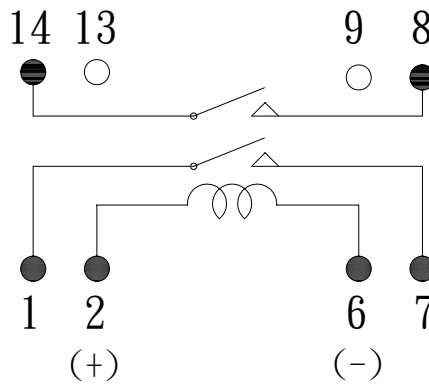

PRODUCT SPECIFICATION

cosmo ELECTRONICS CORPORATION	Reed Relay :	NO. 50R01015	REV.
	D2A240000	SHEET 2 OF 3	5

3.0 COIL RATINGS : (AT 20°C)

3.1	Coil resistance	2150	Ω	(±10%)
3.2	Nominal coil voltage	24	VDC	
3.3	Maximum Continuous voltage	28	VDC	
3.4	Must operate	18	VDC	
3.5	Must release	2.4	VDC	
3.6	Rated current	11.1	mA	

4.0 ELECTRONICAL CHARACTERISTICS :

4.1	Contact resistance	100	mΩ	(max)
4.2	Operate time	0.5	ms	(max)
4.3	Bounce time	0.5	ms	(max)
4.4	Release time	0.2	ms	(max)
4.5	Insulation resistance	(100 VDC open contact)	10 ¹¹	Ω (min)
4.6	Power	10	VA	(max)
4.7	Switching voltage	200	VDC	(max)
4.8	Switching current	0.5	A	(max)
4.9	Carry current	1.0	A	(max)
4.10	Breakdown voltage	(across open contact)	250	VDC (min)
		(between coil & contact)	500	VDC (min)
4.11	Life expectancy	(signal level)	10 ⁸	
4.12	Operating temp		-40 to 85°C	
4.13	Storage temp		-50 to 125°C	
4.14	Resonant frequency		3.5	KHZ
4.15	Vibration (10-2000HZ)		20	g (max)
4.16	Minimum permissible load		100	mVDC 10uA

PRODUCT SPECIFICATION

cosmo ELECTRONICS CORPORATION	Reed Relay :	NO.50R01015	REV.
	D2A240000	SHEET 3 OF 3	5

- **Application Notice**

The statements regarding the suitability of products for certain types of applications are based on cosmo's knowledge of general applications of cosmo products. Such statements are not binding statements about the suitability of products for a particular application. It is the customer's responsibility to verify the specifications are suitable for use in a particular application. Customers are solely responsible for all aspects of their own product design or applications. The parameters provided in the datasheet may vary in different applications and performance may vary over time. All operating parameters (including typical parameters) must be validated by customer's technical experts for different applications. cosmo assumes no liability for customer' product design or applications. Product specifications do not expand or otherwise change cosmo's terms and conditions of purchase, including but not limited to the warranty expressed therein.

When using cosmo products, please comply with safety standards and instructions. cosmo has no liability and responsibility to the damage caused by improper use of the instructions specified in the specifications.

cosmo products are designed for use in general electronic equipment such as telecommunications, office automation equipments, personal computers, test and measurement equipments, consumer electronics, industrial control, instrumentation, audio, video.

cosmo devices shall not be used in equipment that requires higher level of reliability and safety, such as nuclear power control equipment, telecommunication equipment(trunk lines), space application, medical and other life supporting equipments, and equipment for aircraft, military, automotive or any other application that can cause human injury or death.

cosmo reserves the right to change the specifications, data, characteristics, structure, materials and other contents at any time without notice. Please contact cosmo to obtain the latest specification.

cosmo disclaim any and all liability for any errors, inaccuracies or incompleteness contained in any datasheet or in any other disclosure relating to any product.