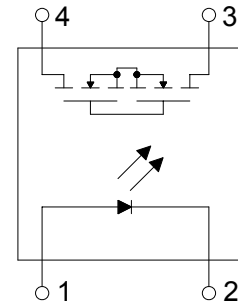


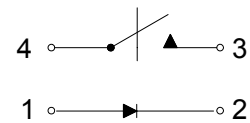
● Description

The KCP1008 series is robust, ideal for telecom and ground fault applications. It is a SPST normally open switch (1 Form A) that replaces electromechanical relays in many applications. It is constructed using a GaAlAs LED for actuation control and an integrated monolithic die for the switch output. The die is fabricated in a high-voltage dielectrically isolated technology and is comprised of a photodiode array, switch control circuitry and MOSFET switches.

● Schematic



1 FORM A
NORMALLY OPEN



● Features

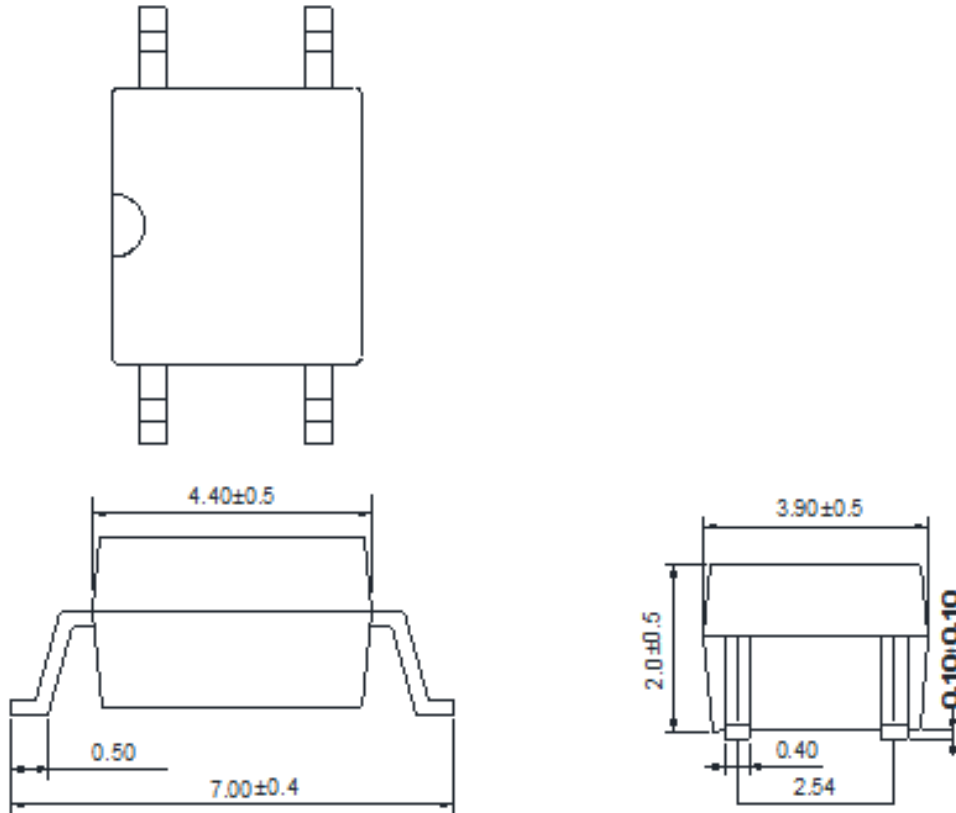
1. Normally open, single pole single throw
2. Control 100V AC or DC voltage
3. Switch 150mA loads
4. Controls low-level analog signals
5. High sensitivity, low ON resistance
6. Low-level off-state leakage current
7. High isolation voltage
8. Pb free and RoHS compliant
9. MSL class 1
10. Agency Approvals :
 - UL Approved (No. E108430): UL508
 - c-UL Approved (No. E108430)
 - FIMKO Approved: EN60065, EN60950

● Applications

- Telecommunications (PC, electronic notepad)
- Modem
- Telephone equipment
- Security equipment
- Sensors
- Measuring and testing equipment
- Factory automation equipment
- High speed inspection machines

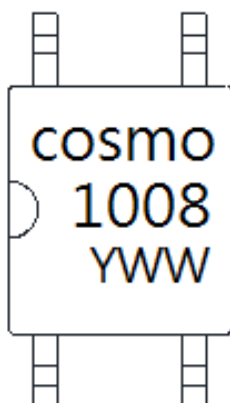
● **Outside Dimension**

Unit : mm



TOLERANCE : ± 0.2 mm

● **Device Marking**



Notes :

cosmo
1008
YWW

Y : Year code / W : Week code

● Absolute Maximum Ratings

(Ta=25°C)

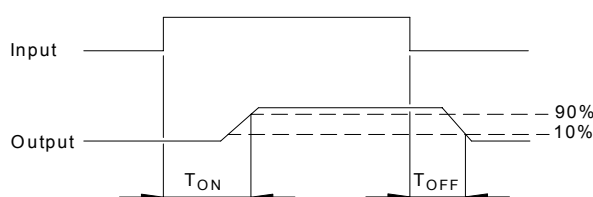
Item		Symbol	Rating	Unit
Input	Continuous forward current	I_F	50	mA
	Peak forward current	I_{FP}	1	A
	Reverse voltage	V_R	5	V
	Power dissipation	P_{in}	100	mW
	Derate linearly from 25°C	-	1.3	mW/°C
Output	Breakdown voltage	V_B	100	V
	Continuous load current	I_L	150	mA
	Power dissipation	P_{out}	500	mW
Isolation voltage		V_{iso}	1500	Vrms
Isolation resistance (Vio=500V)		R_{iso}	$\geq 10^{10}$	Ω
Total power dissipation		P_t	550	mW
Derate linearly from 25°C		-	2.5	mW/°C
Operating temperature		T_{opr}	-40 to +85	°C
Storage temperature		T_{stg}	-40 to +125	°C
Junction temperature		T_j	100	°C
Soldering temperature 10 seconds		T_{sol}	260	°C

● Electro-optical Characteristics

(Ta=25°C)

Parameter		Symbol	Conditions	Min.	Typ.	Max.	Unit
Input	Forward voltage	V_F	$I_F=10\text{mA}$	-	1.2	1.5	V
	Operation input current	I_{FON}	$V_L=20\text{V}, I_L=100\text{mA}$	-	-	2.0	mA
	Recovery input current	I_{FOFF}	$V_L=20\text{V}, I_L \leq 5\mu\text{A}$	0.2	-	-	mA
Output	Breakdown voltage	V_B	$I_B=50\mu\text{A}$	100	-	-	V
	Off-state leakage current	I_{LEAK}	$V_L=100\text{V}, I_F=0\text{mA}$	-	0.2	1.0	μA
I/O capacitance		C_{iso}	$V_B=0\text{V}, f=1\text{MHz}$	-	6	-	pF
ON resistance		R_{ON}	$I_F=10\text{mA}, I_L=100\text{mA}$	-	6	8	Ω
Turn-on time		T_{ON}	$I_F=10\text{mA}, V_L=20\text{V}$	-	0.3	2.0	ms
Turn-off time		T_{OFF}	$I_L=100\text{mA}, t=10\text{ms}$	-	0.1	1.0	ms

● Turn-on / Turn-off Time



● Schematic and Wiring Diagrams

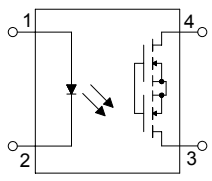
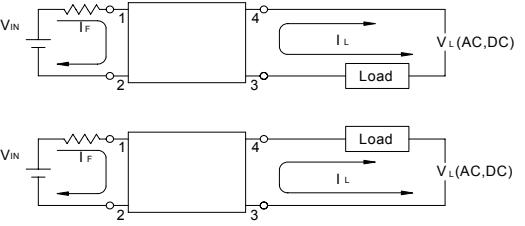
Schematic	Output Configuration	Load	Connection	Wiring Diagrams
	<p>1a</p>	<p>AC DC</p>	<p>-</p>	

Fig.1 Load Current vs. Ambient Temperature

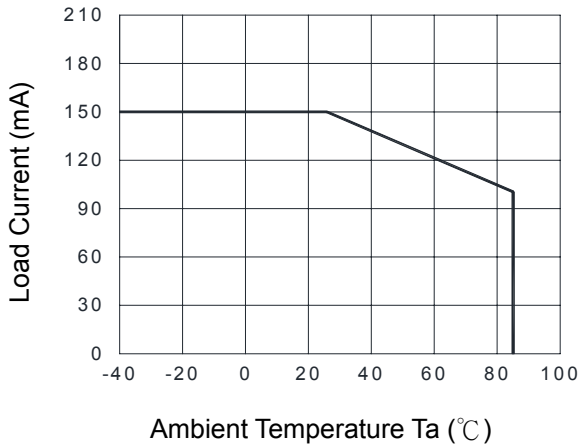


Fig.2 On Resistance vs. Ambient Temperature

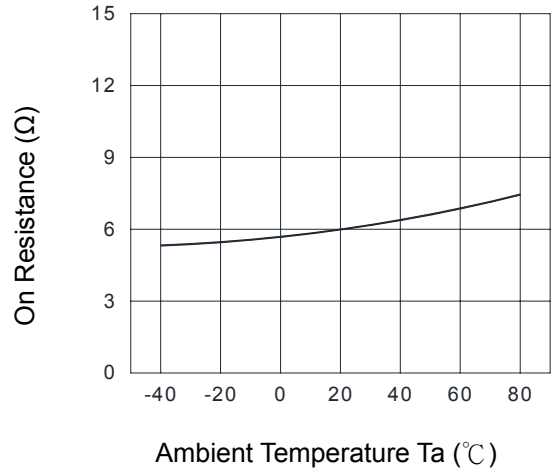


Fig.3 Turn-on Time vs. Ambient Temperature

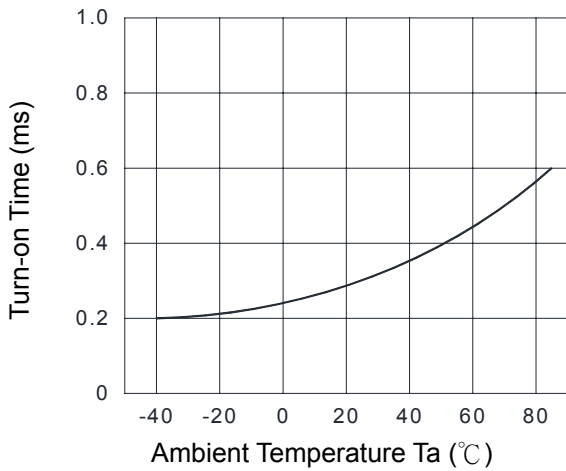


Fig.4 Turn-off Time vs. Ambient Temperature

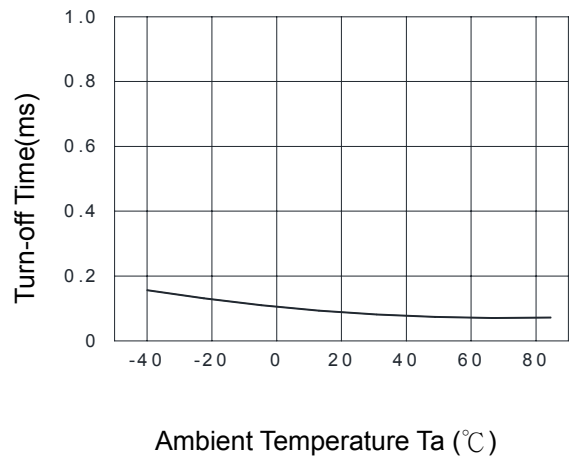


Fig.5 LED Operate Current vs. Ambient Temperature

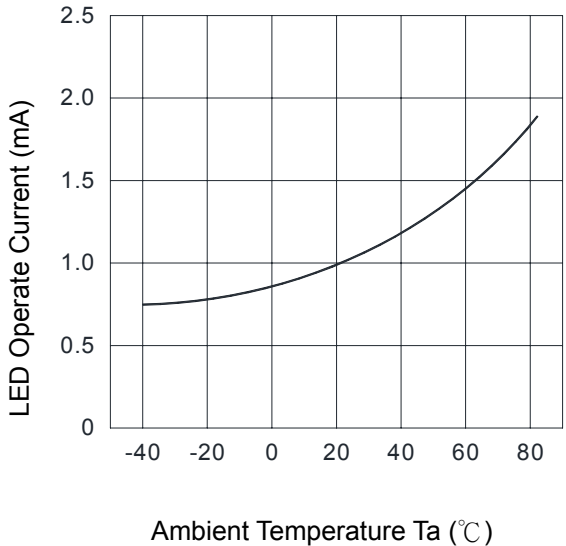


Fig.6 LED Turn-off Current vs. Ambient Temperature

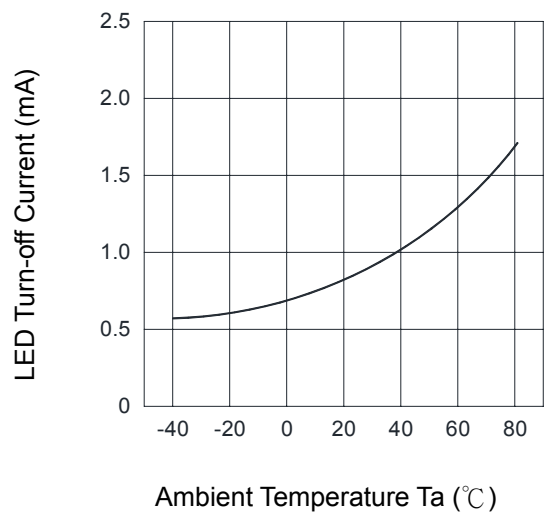


Fig.7 LED Dropout Voltage vs. Ambient Temperature

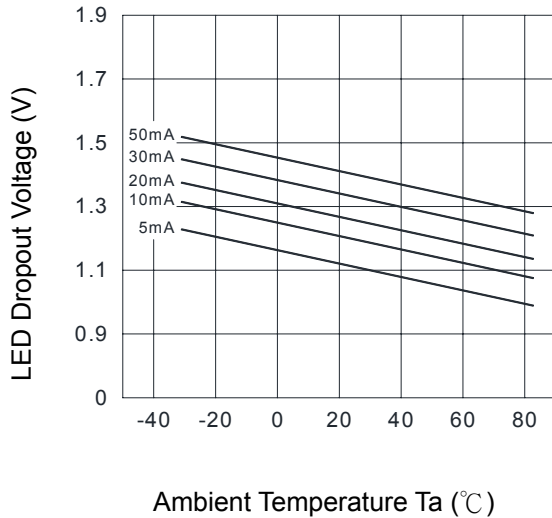


Fig.8 Voltage vs. Current Characteristics of Output at MOSFET Portion

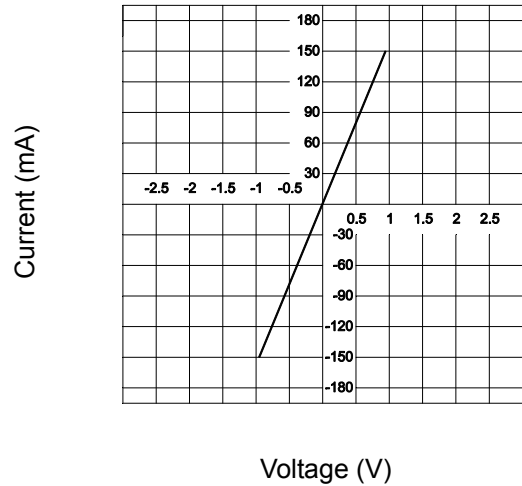


Fig.9 Turn-on Time vs. LED Forward Current

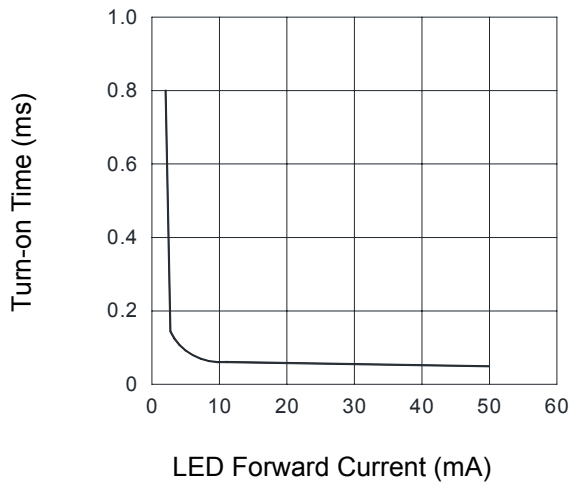


Fig.10 Off-state Leakage Current vs. Load Voltage

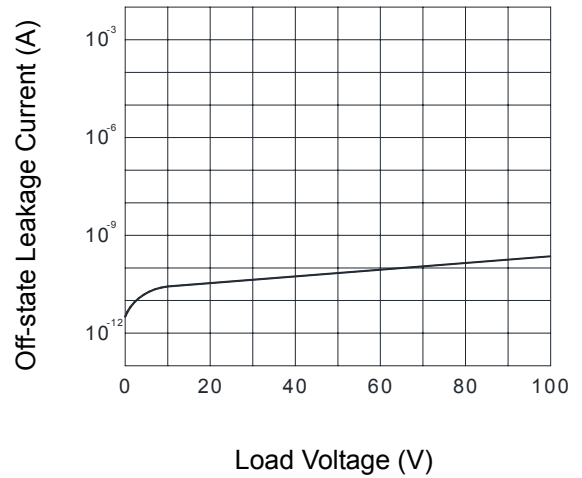


Fig.11 Turn-off Time vs. LED Forward Current

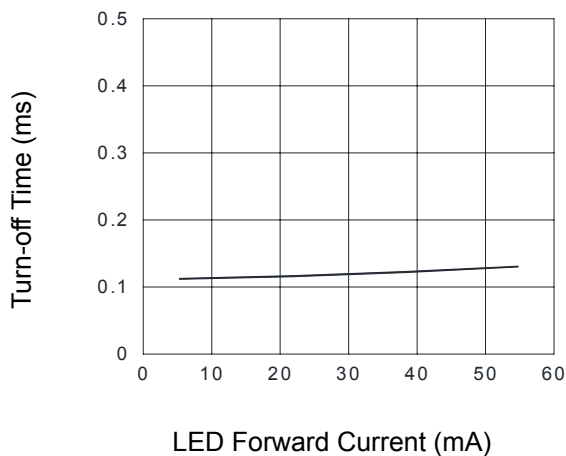
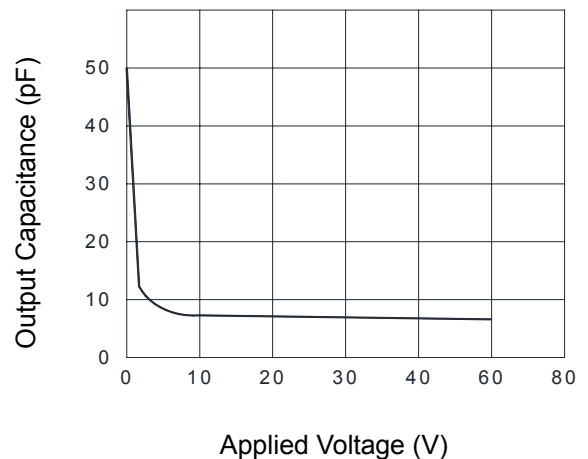
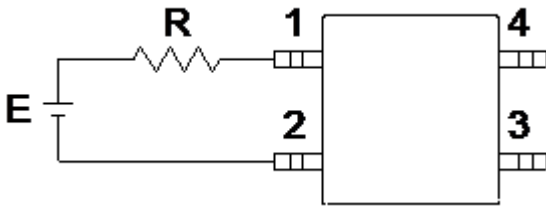


Fig.12 Output Capacitance vs. Applied Voltage



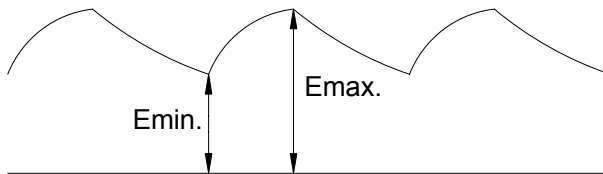
● Using Methods

Examples of resistance value to control LED forward current ($I_f=2\text{mA}$)

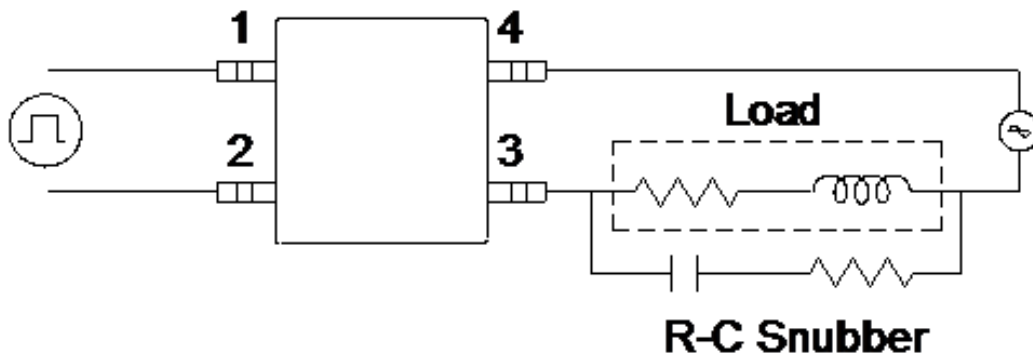
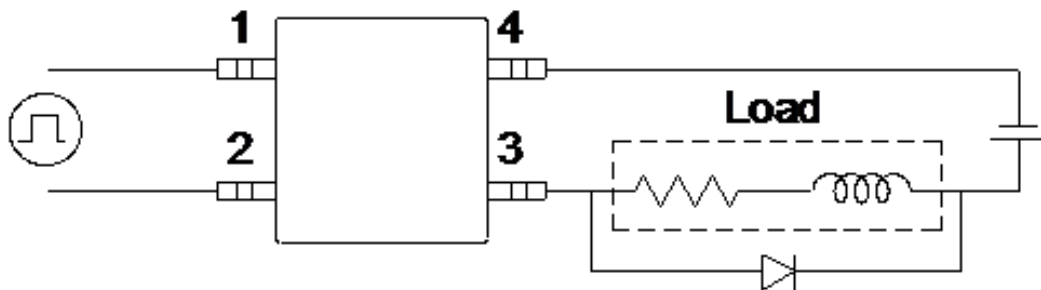


E	R
3.3V	Approx. 720 Ω
5V	Approx. 1.5K Ω
12V	Approx. 4.5K Ω
15V	Approx. 6.0K Ω
24V	Approx. 9.5K Ω

1. LED forward current must be more than 2mA , at E min.
2. LED forward current must be less than 50mA , at E max.



Regulate the spike voltage generated on the inductive load as follows :

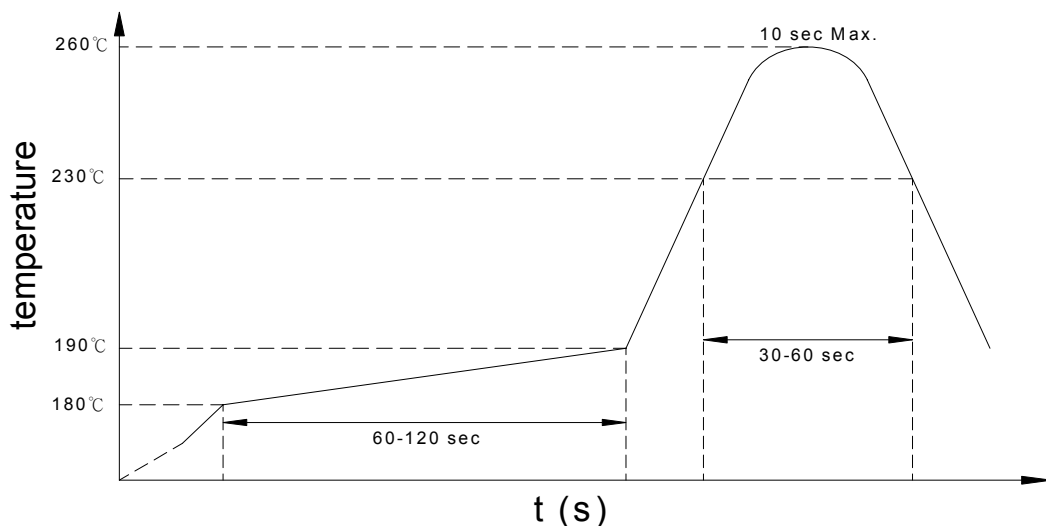


● Recommended Soldering Conditions

(a) Infrared reflow soldering :

- Peak reflow soldering : 260°C or below (package surface temperature)
- Time of peak reflow temperature : 10 sec
- Time of temperature higher than 230°C : 30-60 sec
- Time to preheat temperature from 180~190°C : 60-120 sec
- Time(s) of reflow : Two
- Flux : Rosin flux containing small amount of chlorine (The flux with a maximum chlorine content of 0.2 Wt% is recommended.)

Recommended Temperature Profile of Infrared Reflow



(b) Wave soldering :

- Temperature : 260°C or below (molten solder temperature)
- Time : 10 seconds or less
- Preheating conditions : 120°C or below (package surface temperature)
- Time(s) of reflow : One
- Flux : Rosin flux containing small amount of chlorine (The flux with a maximum chlorine content of 0.2 Wt% is recommended.)

(c) Cautions :

- Fluxes : Avoid removing the residual flux with freon-based and chlorine-based cleaning solvent.
- Avoid shorting between portion of frame and leads.

- **Numbering System**

KCP1008 (X)

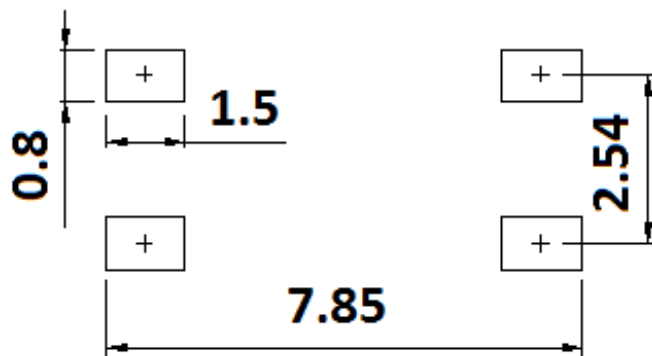
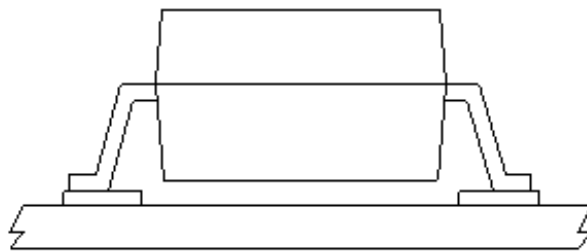
Notes :

KCP1008 = Part No.

X = Tape and reel option (TLD · TRU)

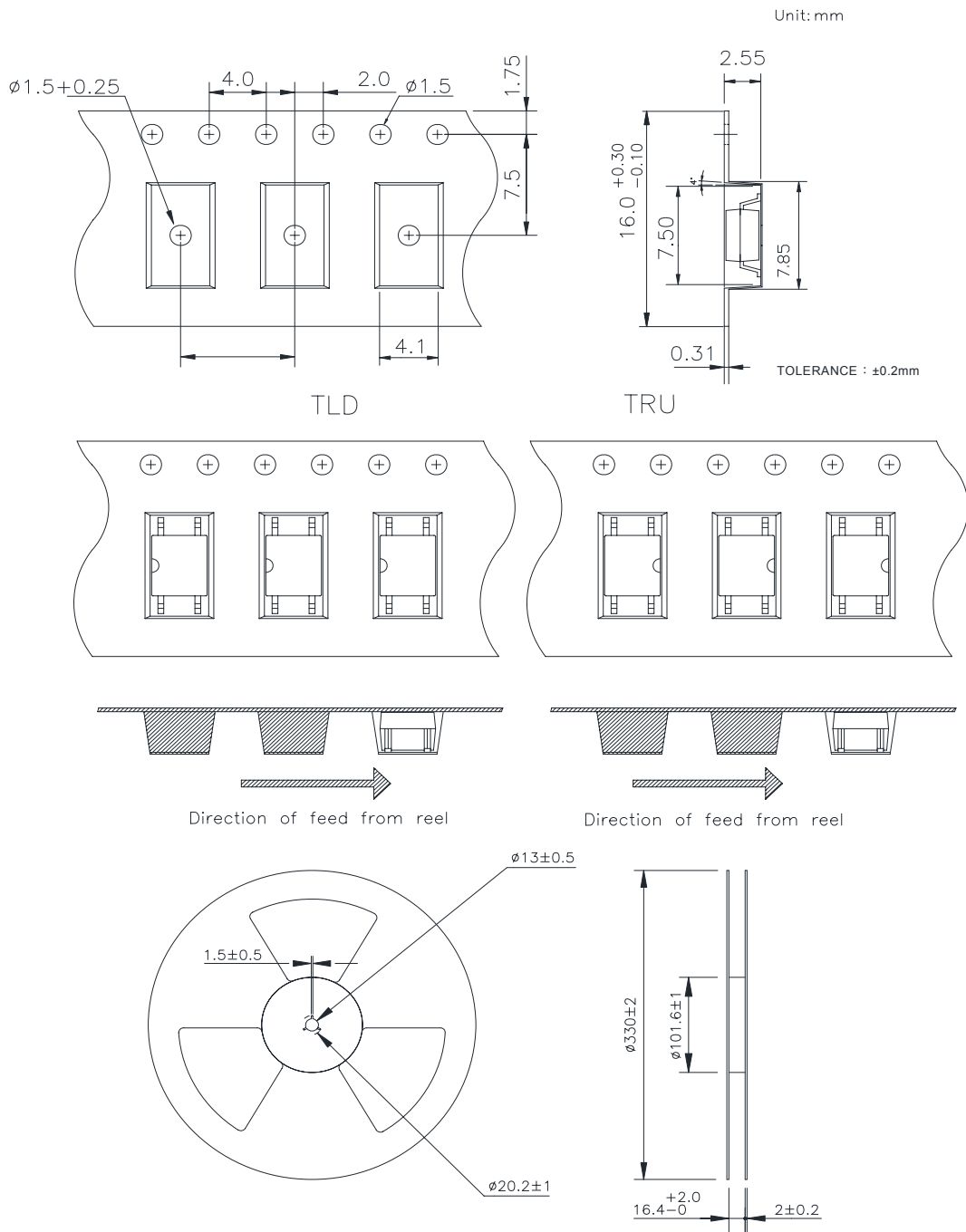
Option	Description	Packing quantity
TLD	small outline for surface mount type package + TLD tape & reel option	3000 units per reel
TRU	small outline for surface mount type package + TRU tape & reel option	3000 units per reel

- **Recommended Pad Layout for Surface Mount Lead Form**



Unit : mm

● 4-pin SOP Carrier Tape & Reel



- **Application Notice**

The statements regarding the suitability of products for certain types of applications are based on cosmo's knowledge of general applications of cosmo products. Such statements are not binding statements about the suitability of products for a particular application. It is the customer's responsibility to verify the specifications are suitable for use in a particular application. Customers are solely responsible for all aspects of their own product design or applications. The parameters provided in the datasheet may vary in different applications and performance may vary over time. All operating parameters (including typical parameters) must be validated by customer's technical experts for different applications. cosmo assumes no liability for customer' product design or applications. Product specifications do not expand or otherwise change cosmo's terms and conditions of purchase, including but not limited to the warranty expressed therein.

When using cosmo products, please comply with safety standards and instructions. cosmo has no liability and responsibility to the damage caused by improper use of the instructions specified in the specifications.

cosmo products are designed for use in general electronic equipment such as telecommunications, office automation equipments, personal computers, test and measurement equipments, consumer electronics, industrial control, instrumentation, audio, video.

cosmo devices shall not be used in equipment that requires higher level of reliability and safety, such as nuclear power control equipment, telecommunication equipment(trunk lines), space application, medical and other life supporting equipments, and equipment for aircraft, military, automotive or any other application that can cause human injury or death.

cosmo reserves the right to change the specifications, data, characteristics, structure, materials and other contents at any time without notice. Please contact cosmo to obtain the latest specification.

cosmo disclaim any and all liability for any errors, inaccuracies or incompleteness contained in any datasheet or in any other disclosure relating to any product.