

● Description

The KPC357NT0T is DC-input single channel which contains a light emitting diode optically coupled to a phototransistor. It is packaged in a 4-pin Mini-Flat package. The input-output Isolation voltage is rated at 3750 Vrms.

● Schematic

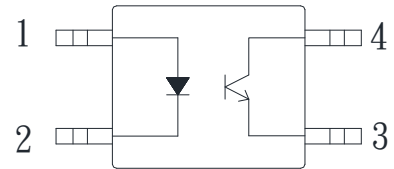

1. Anode
2. Cathode
3. Emitter
4. Collector

● Features

1. Pb free and RoHS compliant
2. Mini-flat package: compact 4 pin SOP with a 2.0mm profile
3. Low input current type ($I_F=1.0\text{mA}$)
4. Current transfer ratio
(CTR : 100~600% at $I_F=1.0\text{mA}$ $V_{ce}=5\text{V}$)
5. High collector-emitter voltage($V_{ce0}:80\text{V}$)
6. High isolation voltage between input and output (Viso:3750Vrms)
7. MSL class 1
8. Agency Approvals:
 - UL Approved (No. E169586): UL1577
 - c-UL Approved (No. E169586)
 - VDE Approved (No. 40014684): DIN EN60747-5-5
 - FIMKO Approved: EN62368-1, EN60601-1
 - CQC Approved: GB8898-2011, GB4943.1-2011

● Applications

- Computer terminals, programmable controllers
- Facsimile equipment, audio, video
- Communications, telephone, etc

● **Outside Dimension**

Unit : mm

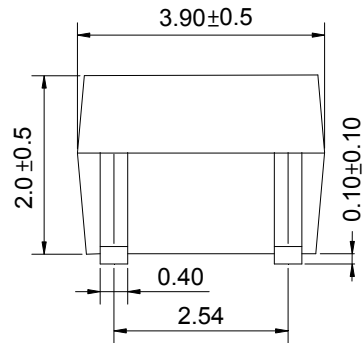
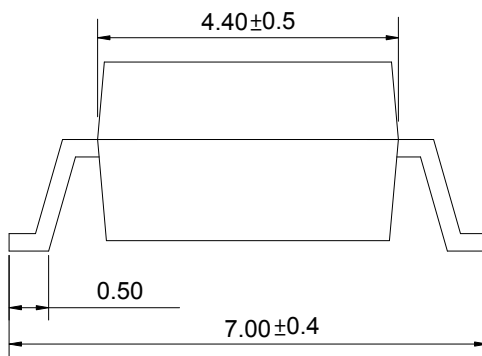
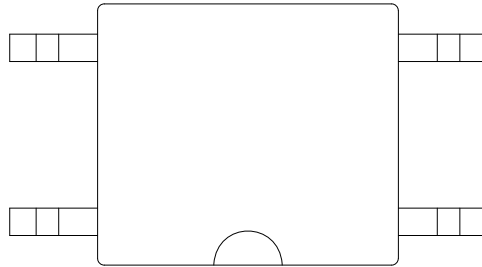

TOLERANCE : ±0.2mm

● **Device Marking**

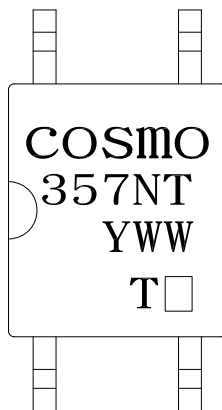

Notes:

Cosmo

357NT

YWW

T□

Y: Year code / WW: Week code

□: CTR rank



KPC357NT0T Series

4PIN MINI-FLAT LOW INPUT CURRENT PHOTOCOUPLER

● Absolute Maximum Ratings

(Ta=25°C)

Parameter		Symbol	Rating	Unit
Input	Forward current	I_F	50	mA
	Peak forward current	I_{FM}	200	mA
	Reverse voltage	V_R	6	V
	Power dissipation	P_D	15	mW
Output	Collector-Emitter voltage	V_{CEO}	80	V
	Emitter-Collector voltage	V_{ECO}	7	V
	Collector current	I_C	50	mA
	Collector power dissipation	P_C	150	mW
Total power dissipation		P_{tot}	170	mW
Isolation voltage 1 minute		V_{iso}	3750	V _{rms}
Operating temperature		T_{opr}	-55 to +115	°C
Storage temperature		T_{stg}	-55 to +125	°C
Soldering temperature 10 seconds		T_{sol}	260	°C

Electro-optical Characteristics

(Ta=25°C)

Parameter		Symbol	Conditions	Min.	Typ.	Max.	Unit
Input	Forward voltage	V_F	$I_F=10mA$	-	1.2	1.4	V
	Reverse current	I_R	$V_R=4V$	-	-	10	μA
	Terminal capacitance	C_t	$V=0, f=1KHz$	-	30	250	pF
Output	Collector dark current	I_{CEO}	$V_{CE}=50V$	-	-	0.1	μA
Transfer characteristics	Current transfer ratio	CTR	$I_F=1mA, V_{CE}=5V$	100	-	600	%
	Collector-Emitter saturation voltage	$V_{CE(sat)}$	$I_F=10mA, I_C=1mA$	-	0.1	0.2	V
	Isolation resistance	Riso	DC500V,40% to 60%RH	5×10^{10}	10^{11}	-	Ω
	Floating capacitance	C_f	$V=0, f=1MHz$	-	0.6	1.0	pF
	Response time (Rise)	t_r	$V_{CE}=2V, I_C=2mA, R_L=100\Omega$	-	4	18	μs
	Response time (Fall)	t_f		-	3	18	μs

Classification table of current transfer ratio is shown below.

CTR Rank.	CTR (%)
KPC357NT0TA	100 TO 600
KPC357NT0TB	200 TO 500
KPC357NT0TC	160 TO 400
KPC357NT0TD	120 TO 300
KPC357NT0TE	100 TO 200

Fig.1 Current Transfer Ratio vs. Forward Current

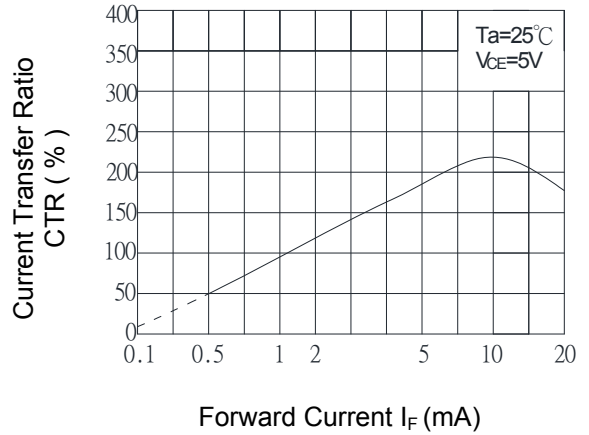

Fig.2 Collector Power Dissipation vs. Ambient Temperature

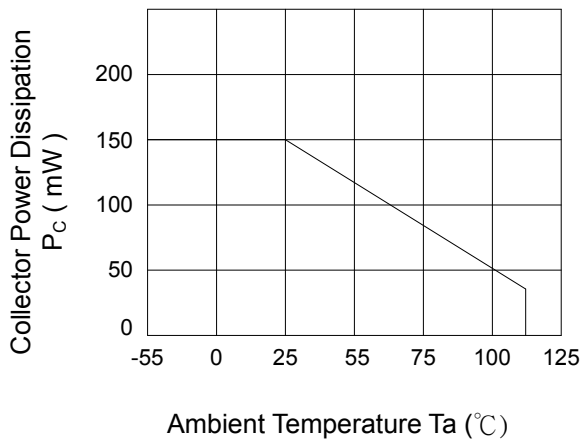

Fig.3 Collector Dark Current vs. Ambient Temperature

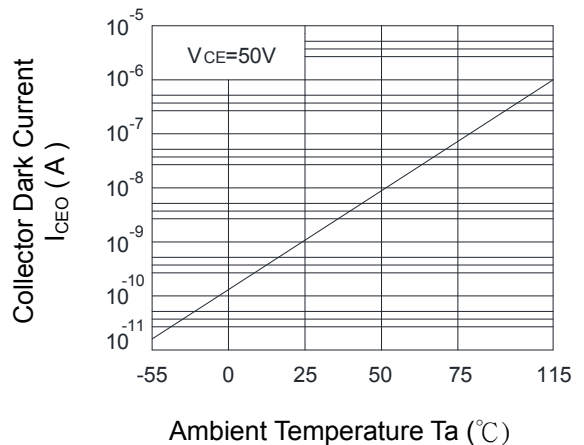

Fig.4 Forward Current vs. Ambient Temperature

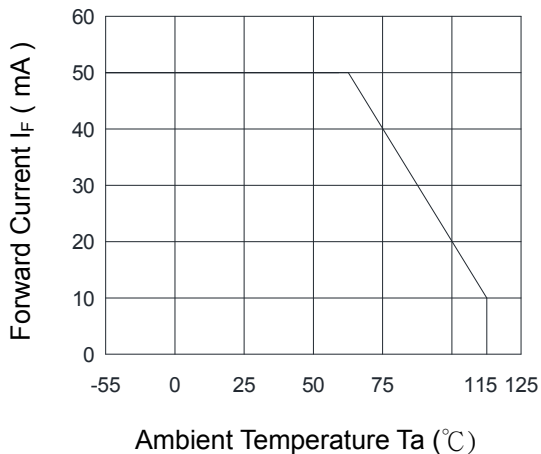

Fig.5 Forward Current vs. Forward Voltage

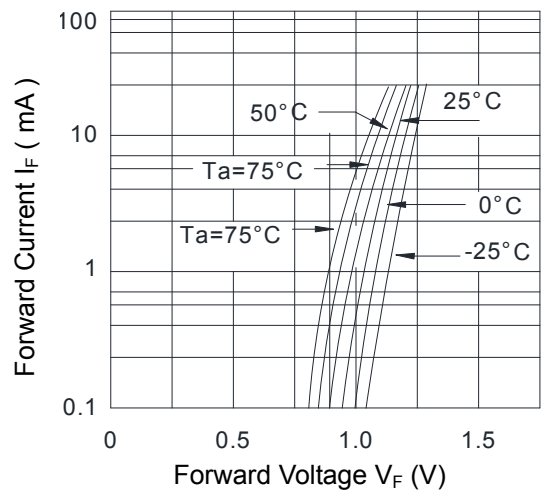

Fig.6 Collector Current vs. Collector-Emitter Voltage

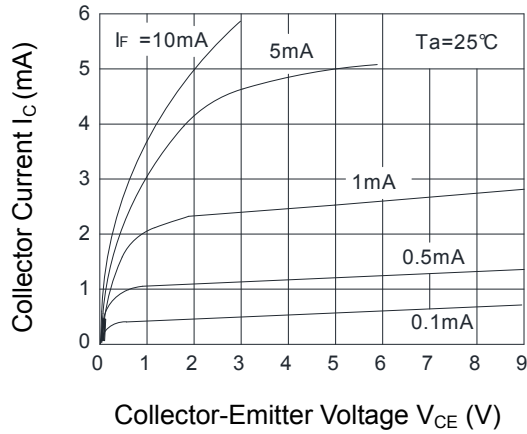

Fig.7 Relative Current Transfer Ratio vs. Ambient Temperature

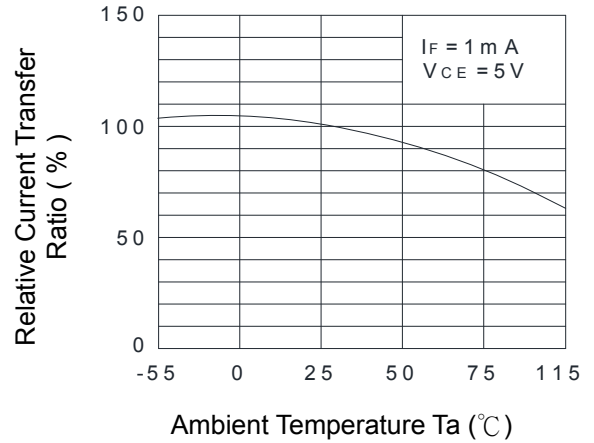

Fig.8 Collector-Emitter Saturation Voltage vs. Ambient Temperature

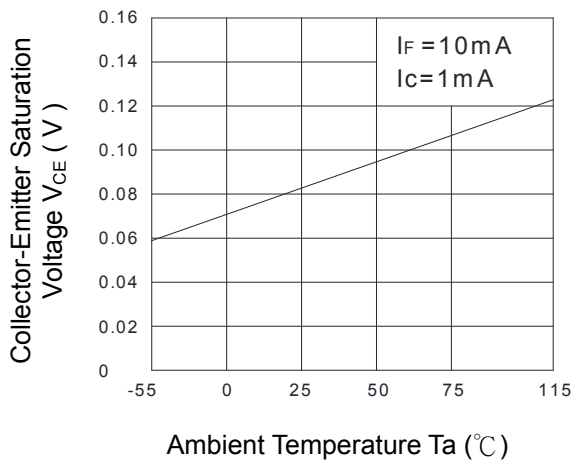

Fig.9 Collector-Emitter Saturation Voltage vs. Forward Current

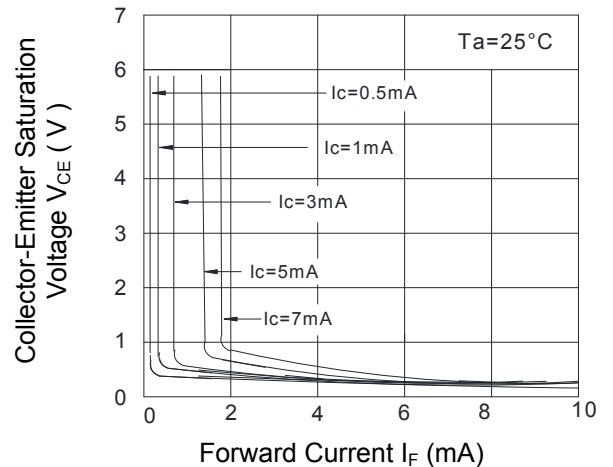

Fig.10 Response Time (Rise) vs. Load Resistance

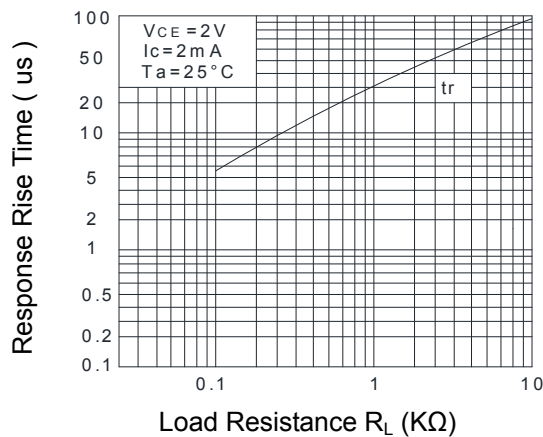
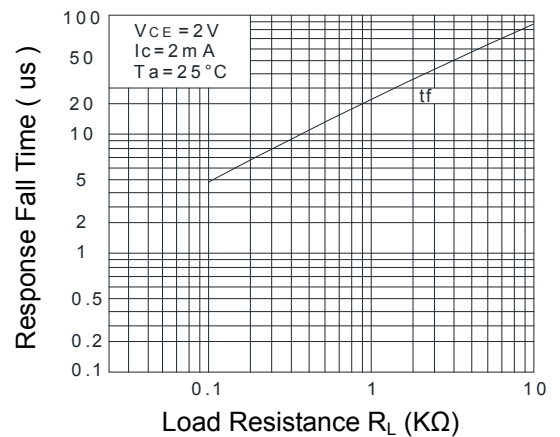
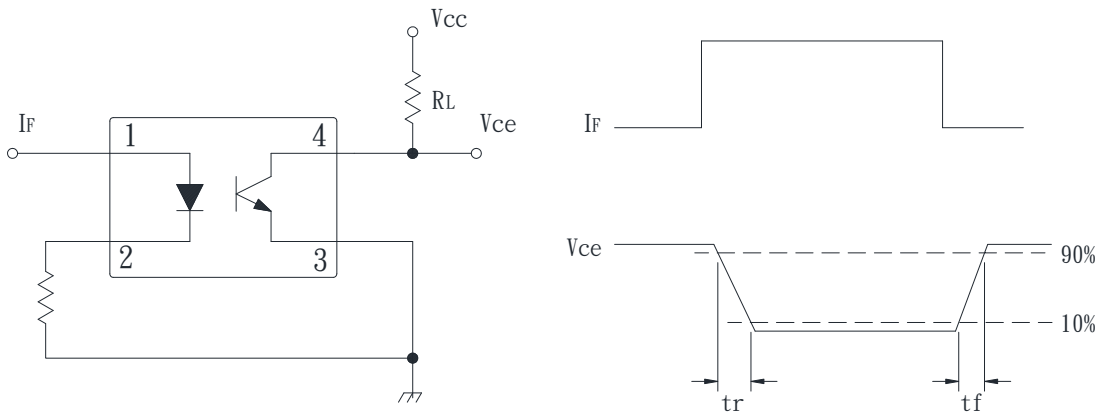

Fig.11 Response Time (Fall) vs. Load Resistance



● **Test Circuit for Response Time**



● Recommended Soldering Conditions

(a) Infrared reflow soldering :

- Peak reflow soldering : 260°C or below (package surface temperature)
- Time of peak reflow temperature : 10 sec
- Time of temperature higher than 230°C : 30-60 sec
- Time to preheat temperature from 180~190°C : 60-120 sec
- Time(s) of reflow : Two
- Flux : Rosin flux containing small amount of chlorine (The flux with a maximum chlorine content of 0.2 Wt% is recommended.)

Recommended Temperature Profile of Infrared Reflow

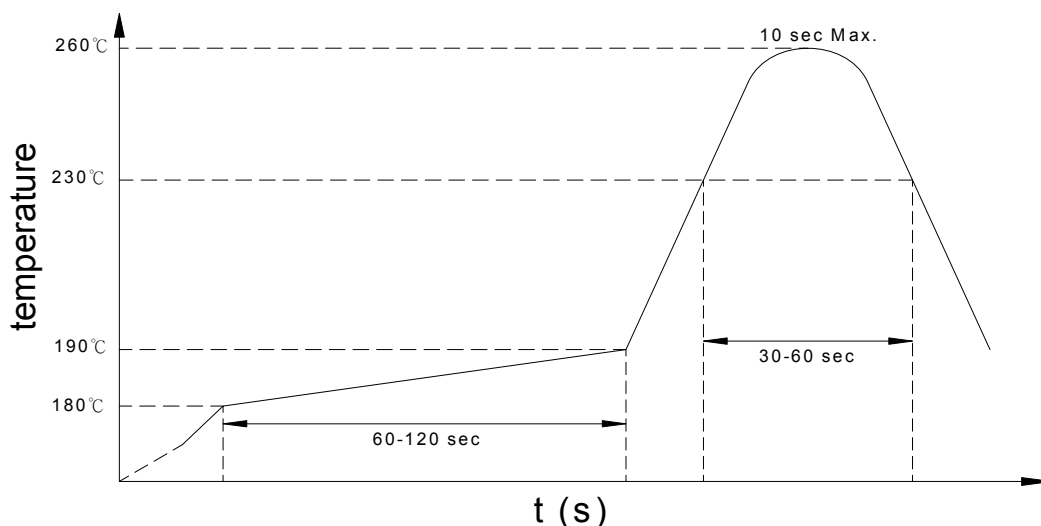

(b) Wave soldering :

- Temperature : 260°C or below (molten solder temperature)
- Time : 10 seconds or less
- Preheating conditions : 120°C or below (package surface temperature)
- Time(s) of reflow : One
- Flux : Rosin flux containing small amount of chlorine (The flux with a maximum chlorine content of 0.2 Wt% is recommended.)

(c) Cautions :

- Fluxes : Avoid removing the residual flux with freon-based and chlorine-based cleaning solvent.
- Avoid shorting between portion of frame and leads.

- **Numbering System**

KPC357NT0T Y (Z)

Notes:

KPC357NT0T = Part No.

Y = CTR rank option (A ~ E)

Z = Tape and reel option (TLD · TRU)

Option	Description	Packing quantity
TLD	TLD tape & reel option	3000 units per reel
TRU	TRU tape & reel option	3000 units per reel

- **Recommended Pad Layout for Surface Mount Lead Form**

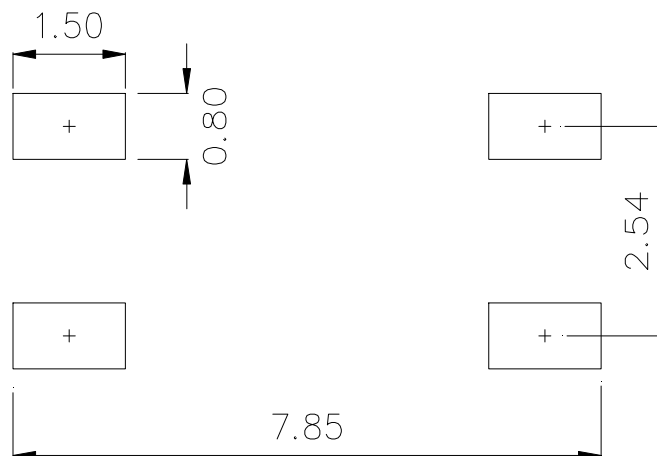
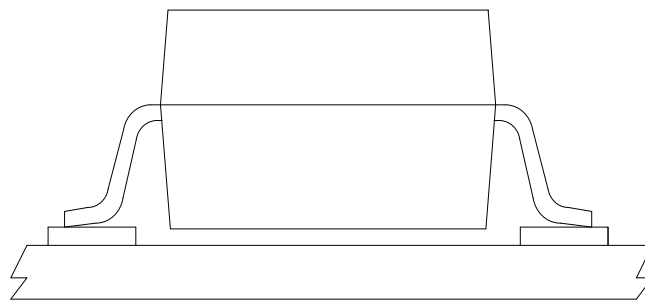

Unit : mm

● 4-pin Mini-Flat Carrier Tape & Reel

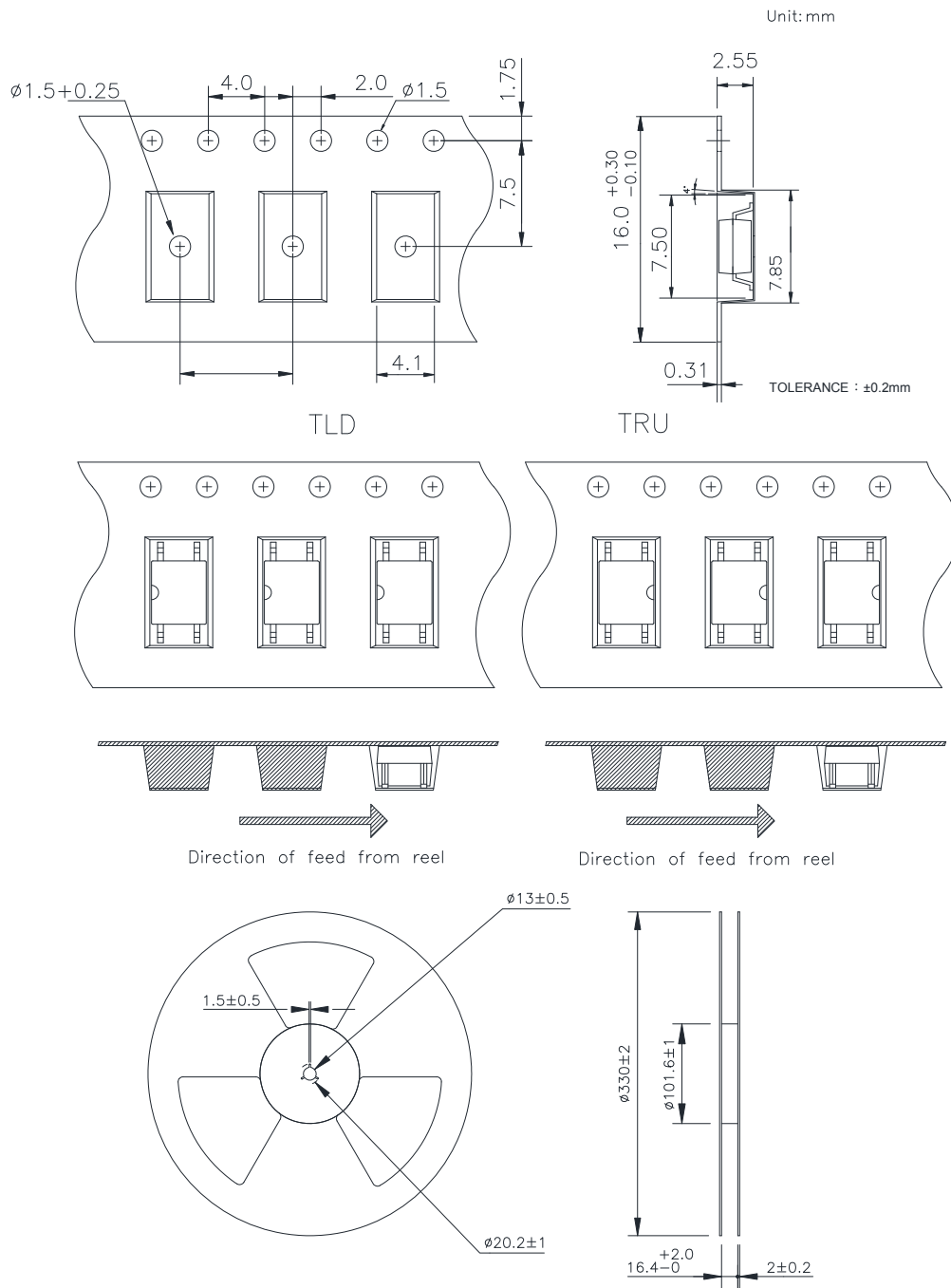



KPC357NT0T Series

4PIN MINI-FLAT LOW INPUT CURRENT PHOTOCOUPLER

● Application Notice

The statements regarding the suitability of products for certain types of applications are based on cosmo's knowledge of general applications of cosmo products. Such statements are not binding statements about the suitability of products for a particular application. It is the customer's responsibility to verify the specifications are suitable for use in a particular application. Customers are solely responsible for all aspects of their own product design or applications. The parameters provided in the datasheet may vary in different applications and performance may vary over time. All operating parameters (including typical parameters) must be validated by customer's technical experts for different applications. cosmo assumes no liability for customer' product design or applications. Product specifications do not expand or otherwise change cosmo's terms and conditions of purchase, including but not limited to the warranty expressed therein.

When using cosmo products, please comply with safety standards and instructions. cosmo has no liability and responsibility to the damage caused by improper use of the instructions specified in the specifications.

cosmo products are designed for use in general electronic equipment such as telecommunications, office automation equipments, personal computers, test and measurement equipments, consumer electronics, industrial control, instrumentation, audio, video.

cosmo devices shall not be used in equipment that requires higher level of reliability and safety, such as nuclear power control equipment, telecommunication equipment(trunk lines), space application, medical and other life supporting equipments, and equipment for aircraft, military, automotive or any other application that can cause human injury or death.

cosmo reserves the right to change the specifications, data, characteristics, structure, materials and other contents at any time without notice. Please contact cosmo to obtain the latest specification.

cosmo disclaim any and all liability for any errors, inaccuracies or incompleteness contained in any datasheet or in any other disclosure relating to any product.